

# PM200DSA120

FLAT-BASE TYPE  
INSULATED PACKAGE

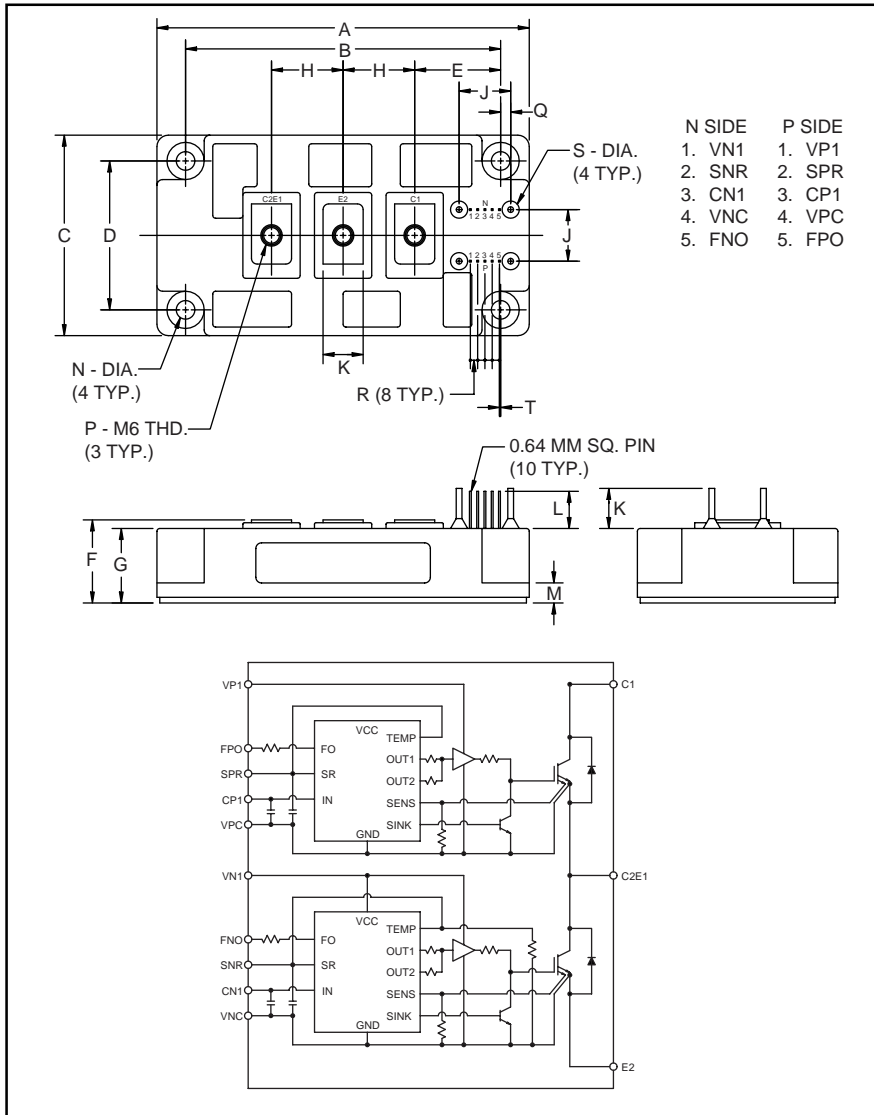

**Description:**

Mitsubishi Intelligent Power Modules are isolated base modules designed for power switching applications operating at frequencies to 20kHz. Built-in control circuits provide optimum gate drive and protection for the IGBT and free-wheel diode power devices.

**Features:**

- Complete Output Power Circuit
- Gate Drive Circuit
- Protection Logic
  - Short Circuit
  - Over Current
  - Over Temperature
  - Under Voltage

**Applications:**

- Inverters
- UPS
- Motion/Servo Control
- Power Supplies

**Ordering Information:**

Example: Select the complete part number from the table below -i.e. PM200DSA120 is a 1200V, 200 Ampere Intelligent Power Module.

Type	Current Rating Amperes	V <sub>CES</sub> Volts (x 10)
PM	200	120

**Outline Drawing and Circuit Diagram**

Dimensions	Inches	Millimeters
A	5.12	130.0
B	4.33±0.010	110.0±0.25
C	2.76	70.0
D	2.05±0.010	52.0±0.25
E	1.18	30.0
F	1.14 +0.04/-0.02	29.0 +1/-0.5
G	1.02	26.0
H	0.98	25.0
J	0.71	18.0

Dimensions	Inches	Millimeters
K	0.55	14.0
L	0.51	13.0
M	0.28	7.0
N	0.26 Dia.	Dia. 6.5
P	M6 Metric	M6
Q	0.14	3.5
R	0.100	2.54
S	0.08 Dia.	Dia. 2.0
T	0.016	0.42

# PM200DSA120

FLAT-BASE TYPE  
INSULATED PACKAGE

## Absolute Maximum Ratings, $T_j = 25^\circ\text{C}$ unless otherwise specified

Ratings	Symbol	PM200DSA120	Units
Power Device Junction Temperature	$T_j$	-20 to 150	$^\circ\text{C}$
Storage Temperature	$T_{\text{stg}}$	-40 to 125	$^\circ\text{C}$
Case Operating Temperature	$T_C$	-20 to 100	$^\circ\text{C}$
Mounting Torque, M6 Mounting Screws	—	3.92~5.88	N · m
Mounting Torque, M6 Main Terminal Screws	—	3.92~5.88	N · m
Module Weight (Typical)	—	630	Grams
Supply Voltage Protected by OC and SC ( $V_D = 13.5 - 16.5\text{V}$ , Inverter Part)	$V_{\text{CC(prot.)}}$	800	Volts
Isolation Voltage (Main Terminal to Baseplate, AC 1 min.)	$V_{\text{iso}}$	2500	Vrms

## Control Sector

Supply Voltage (Applied between $V_{P1}-V_{PC}$ , $V_{N1}-V_{NC}$ )	$V_D$	20	Volts
Input Voltage (Applied between $C_{P1}-V_{PC}$ , $C_{N1}-V_{NC}$ )	$V_{\text{CIN}}$	10	Volts
Fault Output Supply Voltage (Applied between $F_{PO}-V_{PC}$ and $F_{NO}-V_{NC}$ )	$V_{\text{FO}}$	20	Volts
Fault Output Current (Sink Current at $F_{PO}$ , $F_{NO}$ Terminal)	$I_{\text{FO}}$	20	mA

## IGBT Inverter Sector

Collector-Emitter Voltage ( $V_D = 15\text{V}$ , $V_{\text{CIN}} = 5\text{V}$ )	$V_{\text{CES}}$	1200	Volts
Collector Current, ( $T_C = 25^\circ\text{C}$ )	$I_C$	200	Amperes
Peak Collector Current, ( $T_C = 25^\circ\text{C}$ )	$I_{\text{CP}}$	400	Amperes
Supply Voltage (Applied between C1 - E2)	$V_{\text{CC}}$	900	Volts
Supply Voltage, Surge (Applied between C1 - E2)	$V_{\text{CC(surge)}}$	1000	Volts
Collector Dissipation	$P_C$	1140	Watts

## PM200DSA120

FLAT-BASE TYPE  
INSULATED PACKAGEElectrical and Mechanical Characteristics,  $T_j = 25^\circ\text{C}$  unless otherwise specified

Characteristics	Symbol	Test Conditions	Min.	Typ.	Max.	Units
<b>Control Sector</b>						
Over Current Trip Level Inverter Part	OC	$-20^\circ\text{C} \leq T \leq 125^\circ\text{C}$ , $V_D = 15\text{V}$	240	360	—	Amperes
Short Circuit Trip Level Inverter Part	SC	$-20^\circ\text{C} \leq T \leq 125^\circ\text{C}$ , $V_D = 15\text{V}$	320	540	—	Amperes
Over Current Delay Time	$t_{\text{off}}(\text{OC})$	$V_D = 15\text{V}$	—	5	—	$\mu\text{s}$
Over Temperature Protection	OT	Trip Level	100	110	120	$^\circ\text{C}$
	$\text{OT}_r$	Reset Level	85	95	105	$^\circ\text{C}$
Supply Circuit Under Voltage Protection	UV	Trip Level	11.5	12.0	12.5	Volts
	$\text{UV}_r$	Reset Level	—	12.5	—	Volts
Supply Voltage	$V_D$	Applied between $V_{P1}$ - $V_{PC}$ , $V_{N1}$ - $V_{NC}$	13.5	15	16.5	Volts
Circuit Current	$I_D$	$V_D = 15\text{V}$ , $V_{\text{CIN}} = 5\text{V}$ , $V_{N1}$ - $V_{NC}$	—	23	30	mA
		$V_D = 15\text{V}$ , $V_{\text{CIN}} = 5\text{V}$ , $V_{\text{XP1}}$ - $V_{\text{XPC}}$	—	23	30	mA
Input ON Threshold Voltage	$V_{\text{th(on)}}$	Applied between	1.2	1.5	1.8	Volts
Input OFF Threshold Voltage	$V_{\text{th(off)}}$	$C_{P1}$ - $V_{PC}$ , $C_{N1}$ - $V_{NC}$	1.7	2.0	2.3	Volts
PWM Input Frequency	$f_{\text{PWM}}$	3- $\phi$ Sinusoidal	—	15	20	kHz
Fault Output Current	$I_{\text{FO(H)}}$	$V_D = 15\text{V}$ , $V_{\text{FO}} = 15\text{V}$	—	—	0.01	mA
	$I_{\text{FO(L)}}$	$V_D = 15\text{V}$ , $V_{\text{FO}} = 15\text{V}$	—	10	15	mA
Minimum Fault Output Pulse Width	$t_{\text{FO}}$	$V_D = 15\text{V}$	1.0	1.8	—	ms
SXR Terminal Output Voltage	$V_{\text{SXR}}$	$T_j \leq 125^\circ\text{C}$ , $R_{\text{in}} = 6.8 \text{ k}\Omega$ ( $S_{\text{PR}}$ , $S_{\text{NR}}$ )	4.5	5.1	5.6	Volts

## PM200DSA120

FLAT-BASE TYPE  
INSULATED PACKAGEElectrical and Mechanical Characteristics,  $T_j = 25^\circ\text{C}$  unless otherwise specified

Characteristics	Symbol	Test Conditions	Min.	Typ.	Max.	Units
<b>IGBT Inverter Sector</b>						
Collector Cutoff Current	$I_{CES}$	$V_{CE} = V_{CES}, T_j = 25^\circ\text{C}$	—	—	1	mA
		$V_{CE} = V_{CES}, T_j = 125^\circ\text{C}$	—	—	10	mA
Emitter-Collector Voltage	$V_{EC}$	$-I_C = 200\text{A}, V_D = 15\text{V}, V_{CIN} = 5\text{V}$	—	2.5	3.5	Volts
Collector-Emitter Saturation Voltage	$V_{CE(sat)}$	$V_D = 15\text{V}, V_{CIN} = 0\text{V}, I_C = 200\text{A}$	—	2.3	3.2	Volts
		$V_D = 15\text{V}, V_{CIN} = 0\text{V}, I_C = 200\text{A}, T_j = 125^\circ\text{C}$	—	2.1	2.9	Volts
Inductive Load Switching Times	$t_{on}$		0.5	1.4	2.5	$\mu\text{s}$
	$t_{rr}$	$V_D = 15\text{V}, V_{CIN} = 0 \leftrightarrow 5\text{V}$	—	0.2	0.4	$\mu\text{s}$
	$t_{C(on)}$	$V_{CC} = 600\text{V}, I_C = 200\text{A}$	—	0.4	1.0	$\mu\text{s}$
	$t_{off}$	$T_j = 125^\circ\text{C}$	—	2.0	3.5	$\mu\text{s}$
	$t_{C(off)}$		—	0.6	1.1	$\mu\text{s}$

## Thermal Characteristics

Characteristic	Symbol	Condition	Min.	Typ.	Max.	Units
Junction to Case Thermal Resistance	$R_{th(j-c)Q}$	Each IGBT	—	—	0.11	$^\circ\text{C/Watt}$
	$R_{th(j-c)F}$	Each FWDi	—	—	0.18	$^\circ\text{C/Watt}$
Contact Thermal Resistance	$R_{th(c-f)}$	Case to Fin Per Module, Thermal Grease Applied	—	—	0.038	$^\circ\text{C/Watt}$

## Recommended Conditions for Use

Characteristic	Symbol	Condition	Value	Units
Supply Voltage	$V_{CC}$	Applied across C1-E2 Terminals	0 ~ 800	Volts
	$V_D$	Applied between $V_{P1}$ - $V_{PC}$ , $V_{N1}$ - $V_{NC}$	$15 \pm 1.5$	Volts
Input ON Voltage	$V_{CIN(on)}$	Applied between	0 ~ 0.8	Volts
Input OFF Voltage	$V_{CIN(off)}$	$C_{P1}$ - $V_{PC}$ , $C_{N1}$ - $V_{NC}$	$4.0 \sim V_{SXR}$	Volts
PWM Input Frequency	$f_{PWM}$	Using Application Circuit	5 ~ 20	kHz
Minimum Dead Time	$t_{dead}$	Input Signal	$\geq 3.5$	$\mu\text{s}$

# PM200DSA120

FLAT-BASE TYPE  
INSULATED PACKAGE

**SATURATION VOLTAGE CHARACTERISTICS (TYPICAL)**

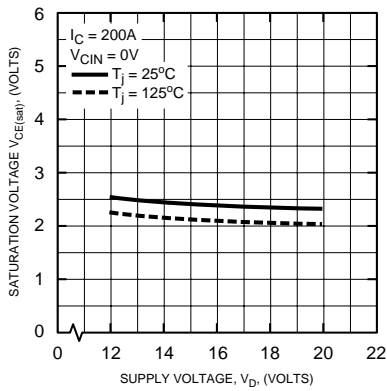

**COLLECTOR-EMITTER SATURATION VOLTAGE CHARACTERISTICS (TYPICAL)**

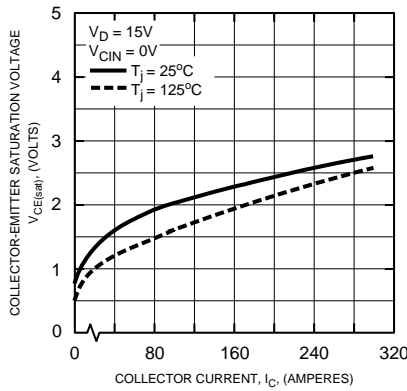

**OUTPUT CHARACTERISTICS (TYPICAL)**

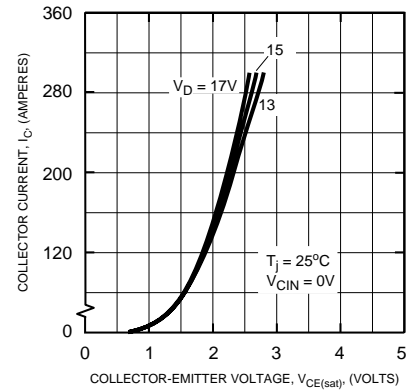

**SWITCHING TIME VS. COLLECTOR CURRENT (TYPICAL)**

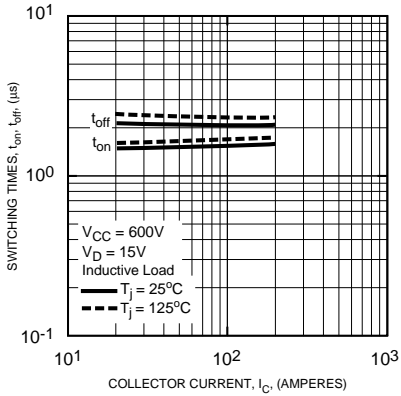

**SWITCHING TIME VS. COLLECTOR CURRENT (TYPICAL)**

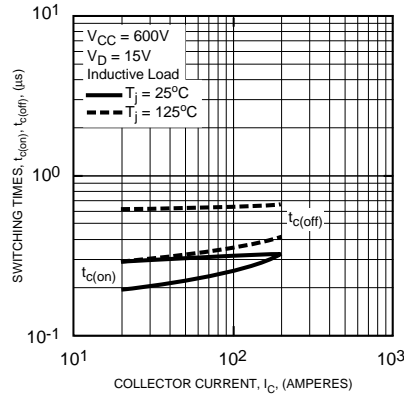

**REVERSE RECOVERY CURRENT VS. COLLECTOR CURRENT (TYPICAL)**

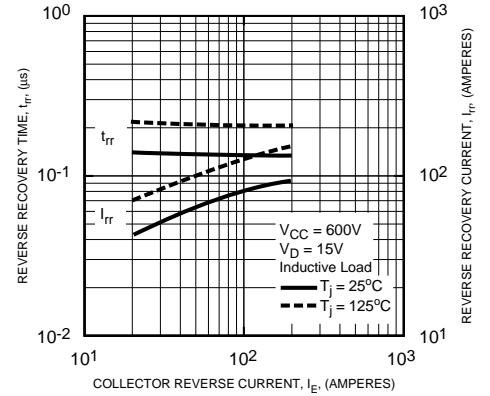

**DIODE FORWARD CHARACTERISTICS**

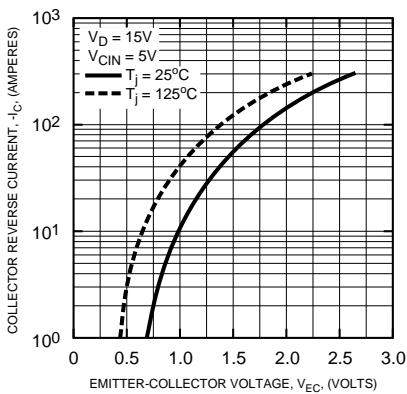

**OVER CURRENT TRIP LEVEL VS. SUPPLY VOLTAGE (TYPICAL)**

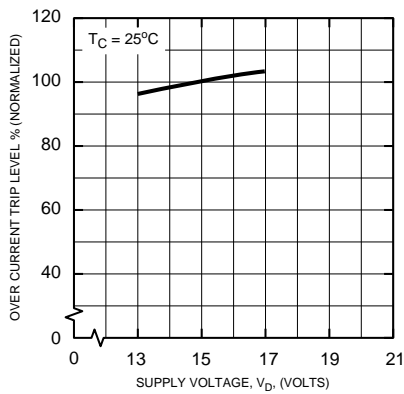

**OVER CURRENT TRIP LEVEL VS. TEMPERATURE (TYPICAL)**

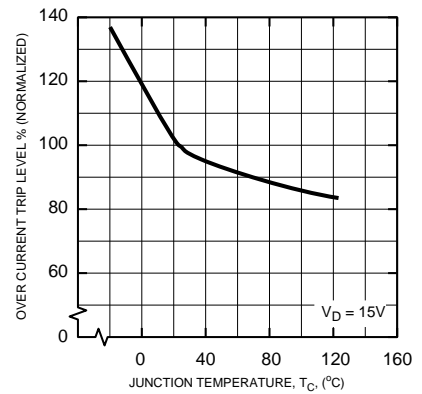

# PM200DSA120

FLAT-BASE TYPE  
INSULATED PACKAGE

**FAULT OUTPUT PULSE WIDTH VS. TEMPERATURE (TYPICAL)**

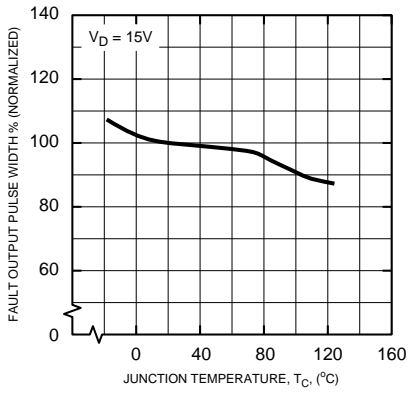

**CONTROL SUPPLY VOLTAGE TRIP-RESET LEVEL TEMPERATURE DEPENDENCY (TYPICAL)**

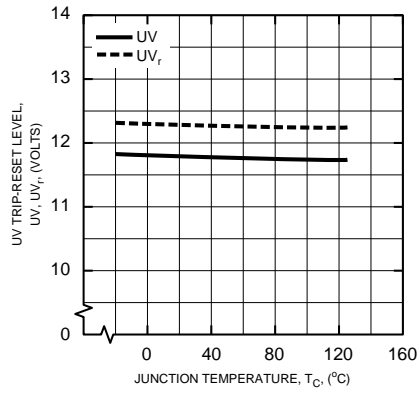

**TRANSIENT THERMAL IMPEDANCE CHARACTERISTICS (Each IGBT)**

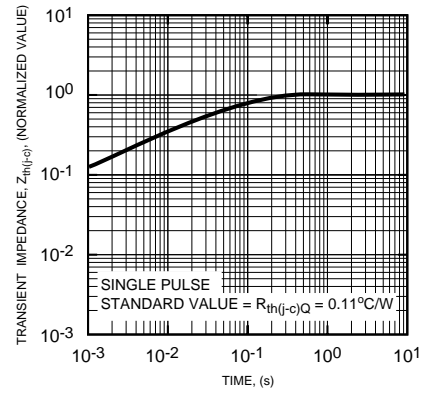

**TRANSIENT THERMAL IMPEDANCE CHARACTERISTICS (Each FWD)**

